



SW

Il nuovo codice sarà fornito solo ad esaurimento del vecchio
 The new code will be supplied only when the old will be out of stock

ACTIVE SAFETY



OSAS

Der neue Kode wird nur angegeben, wenn der alte nicht mehr lieferbar ist



USAS

Le nouveau code sera fourni uniquement lorsque le vieux stock sera écoulé



OPAS

El nuevo código será suministrado sólo cuando se agoten las existencias del antiguo

O novo código irá ser fornecido apenas quando o antigo esgotar stock



* F_{1i} = Isothermal end force at 100% Cu p. 16

** F_{1p} = Polytrophic end force at 100% Cu p. 16

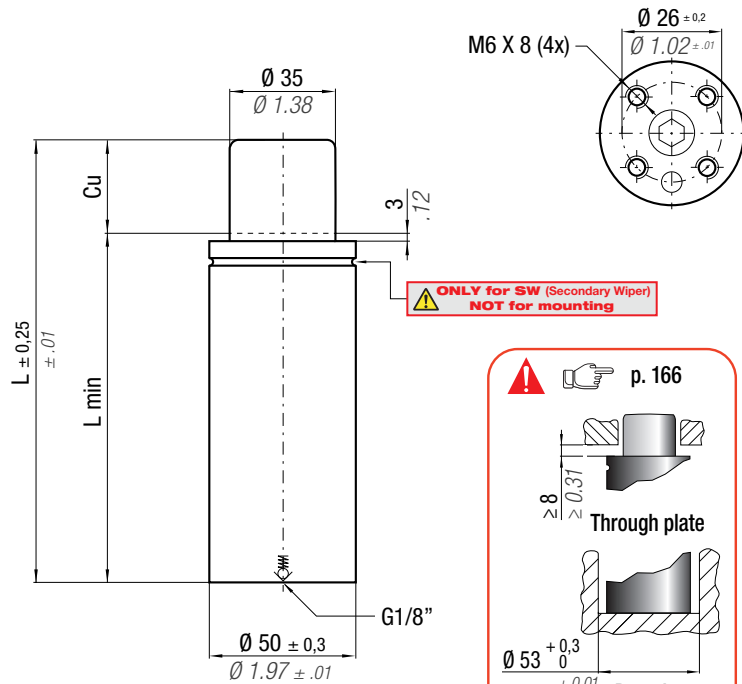

N ₂	0 - 80 °C 32 - 176 °F	ΔP ± 0,33 %/°C	P max 200 bar 2900 psi	P min 20 bar 290 psi	S 9,62 cm ² 1.491 in ²	SPM ~ 40 - 80 (at 20°C)	Max Speed 1,6 m/s 62.9 in/s	Maintenance kit 39BMMLO1800C	
CODE	NEW	Cu	L	L min	F ₀	F _{1i} *	F _{1p} **	V ₀	2014/68/EU
PHASING OUT from 05/2019		mm inch	mm inch	mm inch	Initial force daN lb	End force * daN lb	End force ** daN lb	cm ³ in ³	~Kg ~lb
ML 1800 - 015 - C	ML 1800 - 015 - D	15 0.59	95 3.74	80 3.15	1925 4327	2828 6358	3215 7227	57 3.46	0,76 1.68
ML 1800 - 025 - C	ML 1800 - 025 - D	25 0.98	115 4.53	90 3.54	± 5%	3198 7189	3728 8381	75 4.56	0,85 1.87
ML 1800 - 038 - C	ML 1800 - 038 - D	38 1.50	150 5.91	112 4.41	200 bar 2900 psi	3274 7359	3835 8621	110 6.69	1,01 2.23
ML 1800 - 050 - C	ML 1800 - 050 - D	50 1.97	175 6.89	125 4.92		3471 7802	4115 9252	133 8.10	1,12 2.47
ML 1800 - 063 - C	ML 1800 - 063 - D	63 2.48	205 8.07	142 5.59		3568 8021	4254 9564	161 9.84	1,26 2.78
ML 1800 - 080 - C	ML 1800 - 080 - D	80 3.15	245 9.65	165 6.50	+20 °C +68 °F	3642 8188	4362 9805	200 12.18	1,44 3.17

KIT FOR LINKING

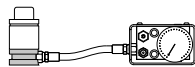

code: 39FML01800C



Seal (1x)



Washer (4x)



Screw (2x)



Bottom base (1x)

Valve (1x)

 Instructions



Sostituire ogni 1.000.000 di cicli. Replace every 1 million cycles. Nach 1 Mio. Hübe austauschen. Remplacez à chaque million de cycles. Reemplazar cada 1 millón de ciclos. Substituir a cada 1 milhão de ciclos.

Bottom base dimension

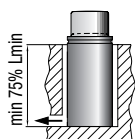
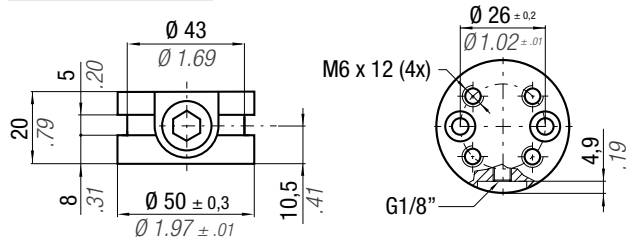

Drop-In

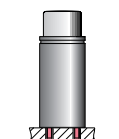

Bottom mount

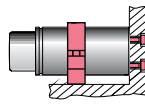

FSA 50 - FSD 50
FSE 50

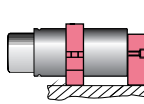

FSD 50 + R 50 A
FSE 50 + R 50 A

HOW TO ORDER

p. 167

INSTALLATION GUIDELINE

p. 205